

Sheath Resistance Temperature Detectors

Model No. SS-5040 Series

Weather Proof Head Type

Model No. | SS-5041W
(Sheath)

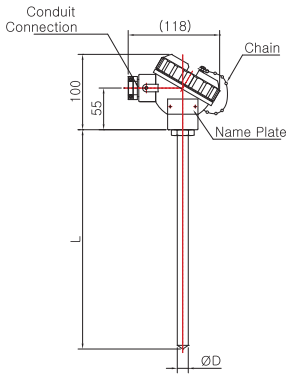

Model No. | SS-5042W
(Sheath)

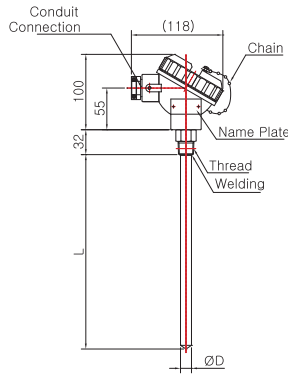

Model No. | SS-5042W-1
(Sheath)

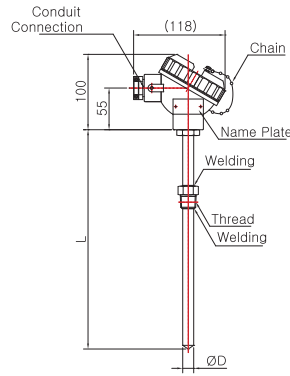

Model No. | SS-5042W-2
(Sheath)

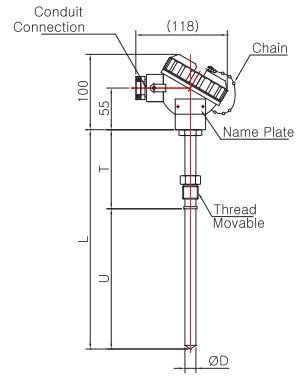

Model No. | SS-5042W-3
(Sheath)

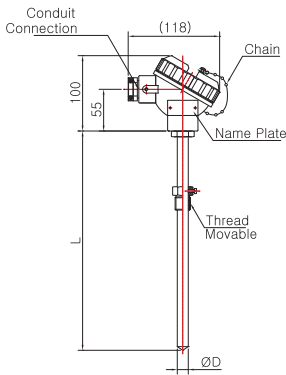

Model No. | SS-5042W-4
(Sheath)

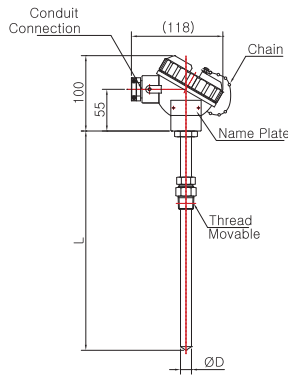

Model No. | SS-5043W
(Sheath)

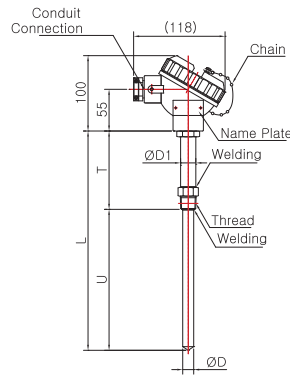

Model No. | SS-5043W-1
(Sheath)

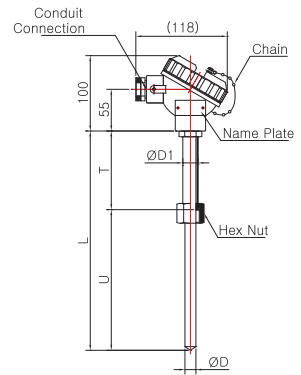

Model No. | SS-5044W-1
(Sheath)

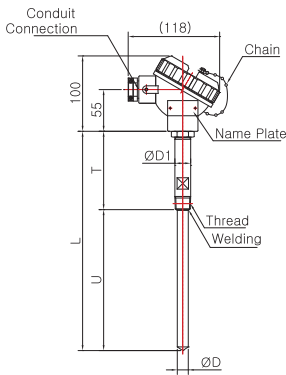

Model No. | SS-5044W-1-1
(Sheath Spring Load)

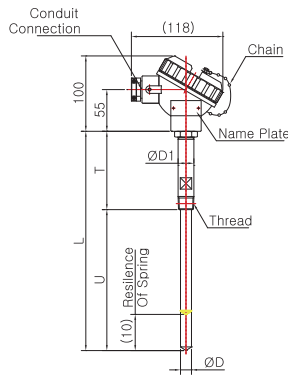

Model No. | SS-5044W-2
(Sheath)

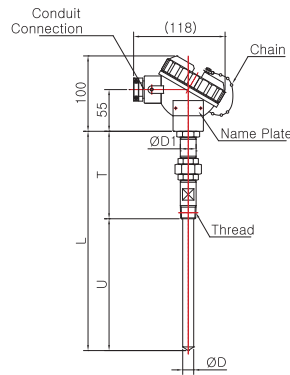

Model No. | SS-5044W-2-1
(Sheath Spring Load)

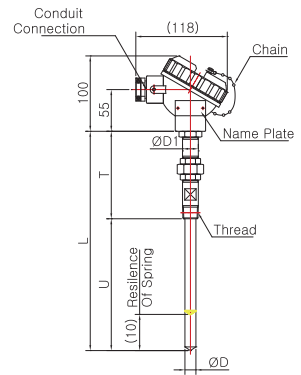

Pressure Gauge
Differential Pressure Gauge & Switch
Accessories of Pressure Gauge
Thermometer & Thermometer Switch
Thermocouple & R.T.D.
Thermowell
Transmitter
Indicator etc.
Technical data

Weather Proof Head Type

Model No. | SS-5045W
(Sheath)

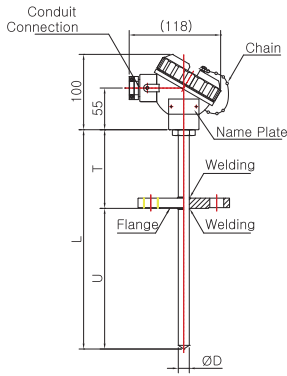

Model No. | SS-5045W-1
(Sheath)

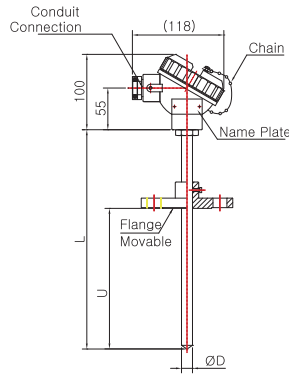

Model No. | SS-5046W-1
(Sheath)

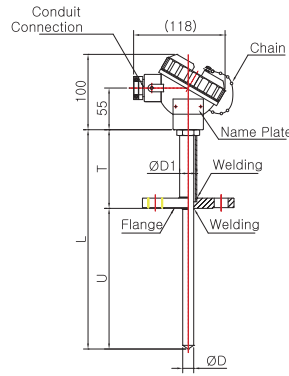

Model No. | SS-5046W-1-1
(Sheath Spring Load)

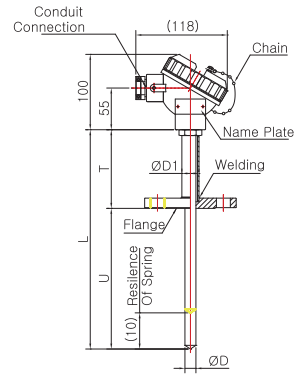

Model No. | SS-5046W-2
(Sheath)

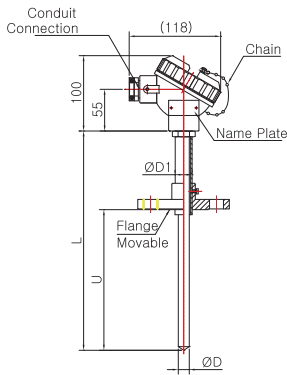

Model No. | SS-5046W-3
(Sheath)

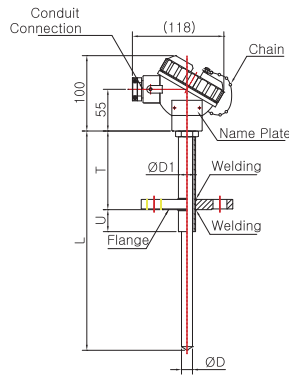

Model No. | SS-5049W
(Sheath)

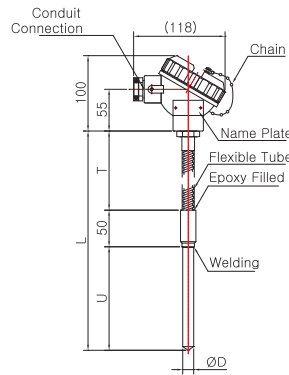

Model No. | SS-5049W-1
(Sheath)

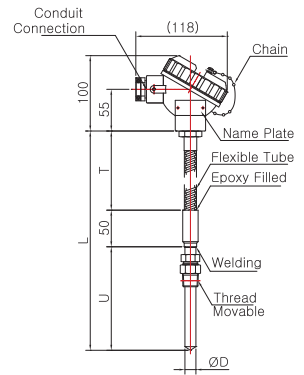

Model No. | SS-5049W-3
(Sheath)

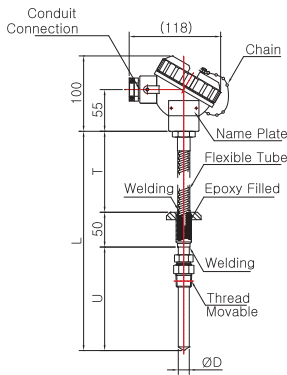

Pressure Gauge
Differential Pressure Gauge & Switch
Accessories of Pressure Gauge
Thermometer & Thermometer Switch
Thermocouple & R.T.D
Thermowell
Transmitter
Indicator etc.
Technical data

Sheath Resistance Temperature Detectors

Model No. SS-5040 Series

Explosion Proof Head Type (Ex d IIC T6)

Model No. | SS-5041E
(Sheath)

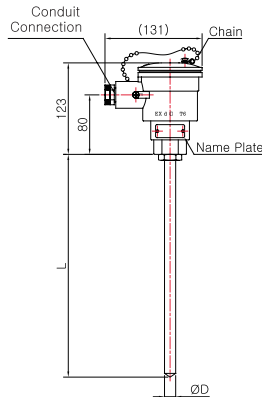

Model No. | SS-5042E
(Sheath)

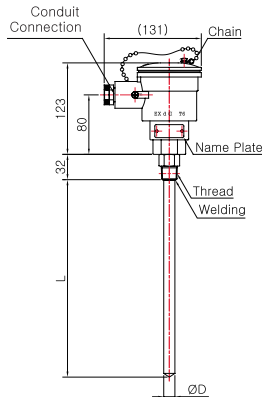

Model No. | SS-5042E-1
(Sheath)

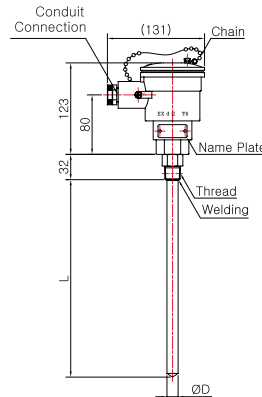

Model No. | SS-5042E-2
(Sheath)

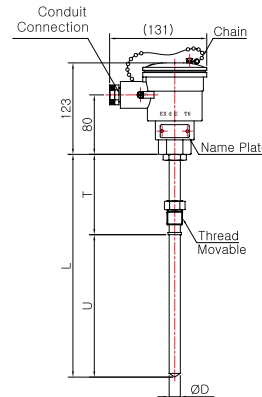

Model No. | SS-5042E-3
(Sheath)

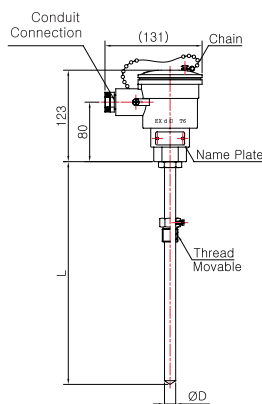

Model No. | SS-5042E-4
(Sheath)

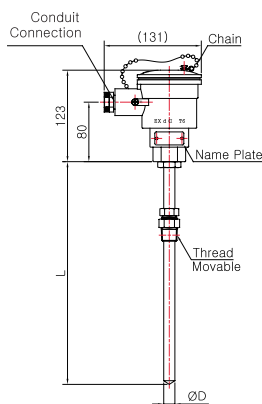

Model No. | SS-5043E
(Sheath)

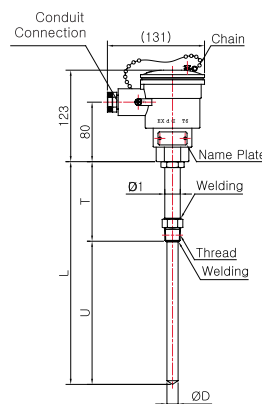

Model No. | SS-5043E-1
(Sheath)

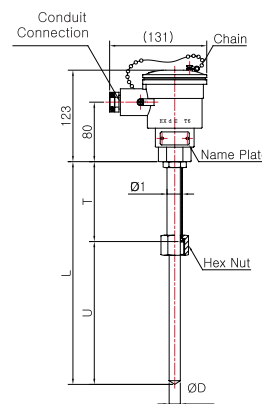

Model No. | SS-5044E-1
(Sheath)

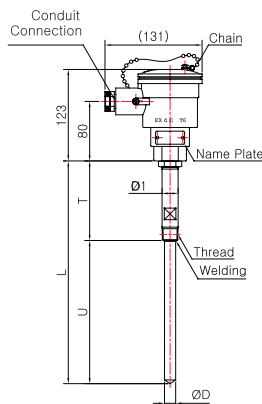

Model No. | SS-5044E-1-1
(Sheath Spring Load)

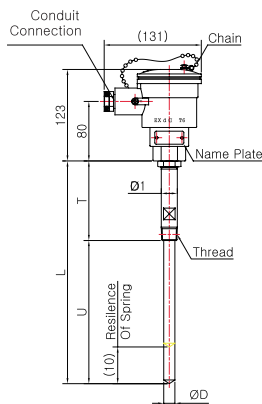

Model No. | SS-5044E-2
(Sheath)

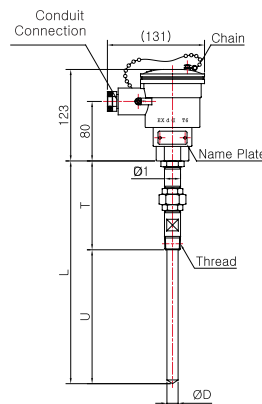

Model No. | SS-5044E-2-1
(Sheath Spring Load)

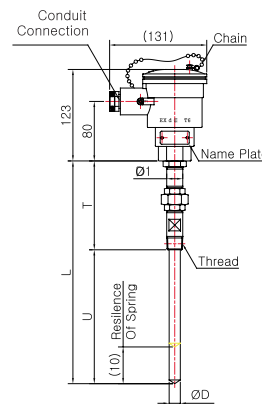

Pressure Gauge
Differential Pressure Gauge & Switch
Accessories of Pressure Gauge
Thermometer & Thermometer Switch
Thermocouple & R.T.D.
Thermowell
Transmitter
Indicator etc.
Technical data

Explosion Proof Head Type (Ex d IIC T6)

Model No. | SS-5045E
(Sheath)

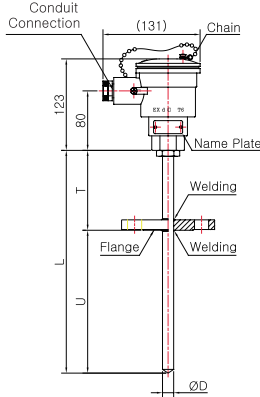

Model No. | SS-5045E-1
(Sheath)

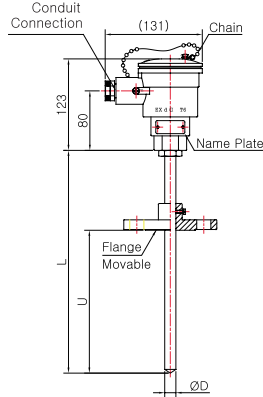

Model No. | SS-5046E-1
(Sheath)

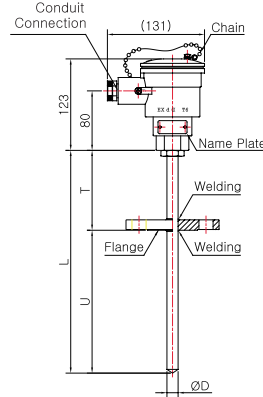

Model No. | SS-5046E-1-1
(Sheath Spring Load)

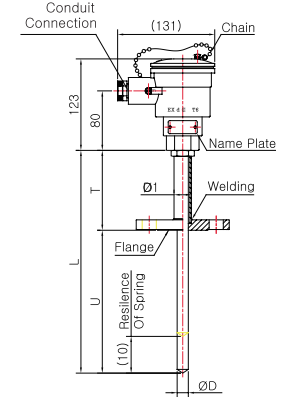

Model No. | SS-5046E-2
(Sheath)

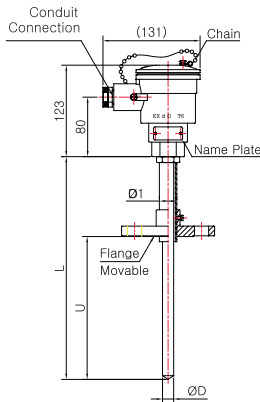

Model No. | SS-5046E-3
(Sheath)

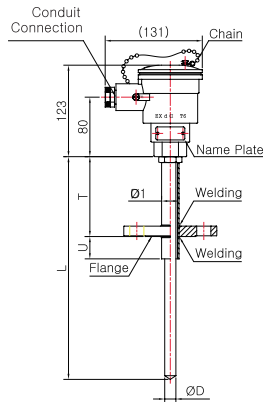

Model No. | SS-5049E
(Sheath)

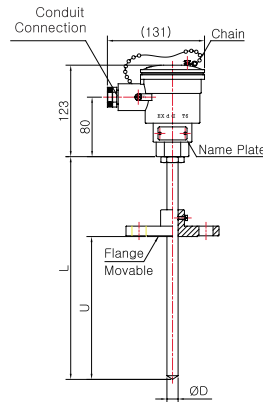

Model No. | SS-5049E-1
(Sheath)

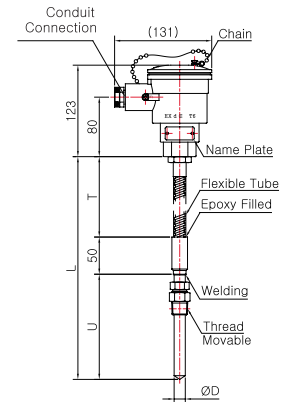

Model No. | SS-5049E-3
(Sheath)

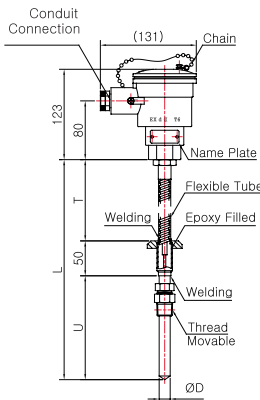

Pressure Gauge

Differential Pressure Gauge & Switch

Accessories of Pressure Gauge

Thermometer & Thermometer Switch

Thermocouple & R.T.D

Thermowell

Transmitter

Indicator etc.

Technical data

Sheath Resistance Temperature Detectors

Model No. SS-5040 Series

General Purpose Head Type

Model No. | SS-5041S
(Sheath)

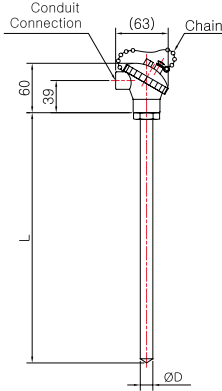

Model No. | SS-5042S
(Sheath)

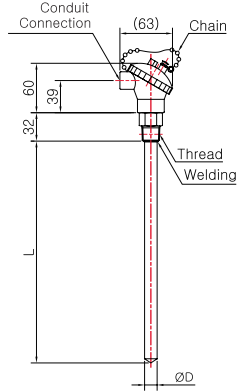

Model No. | SS-5042S-1
(Sheath)

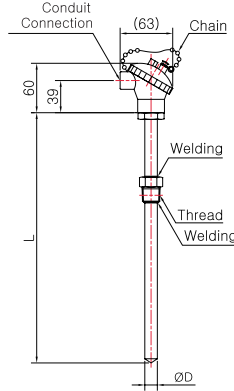

Model No. | SS-5042S-2
(Sheath)

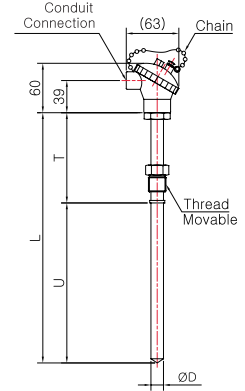

Model No. | SS-5042S-3
(Sheath)

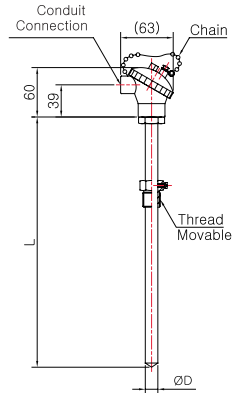

Model No. | SS-5042S-4
(Sheath)

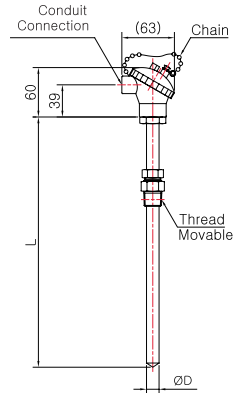

Model No. | SS-5043S
(Sheath)

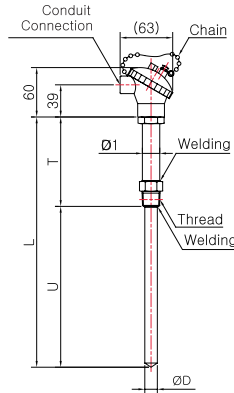

Model No. | SS-5043S-1
(Sheath)

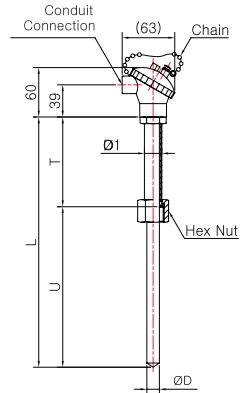

Model No. | SS-5044S-1
(Sheath)

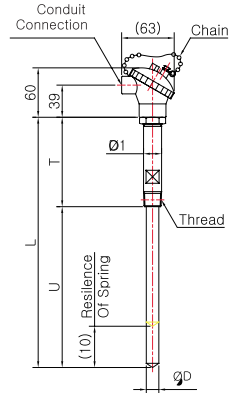

Model No. | SS-5044S-1-1
(Sheath Spring Load)

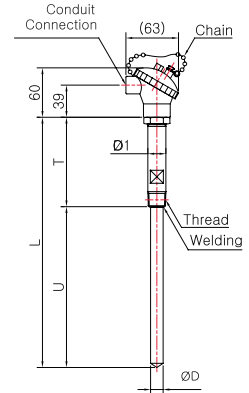

Model No. | SS-5044S-2
(Sheath)

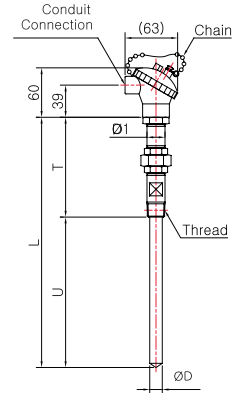

Model No. | SS-5044S-2-1
(Sheath Spring Load)

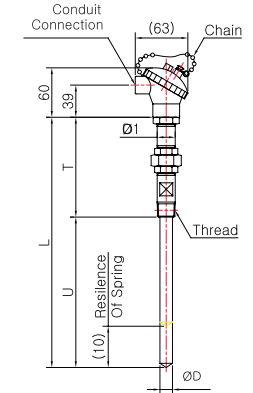

Pressure Gauge
Differential Pressure Gauge & Switch
Accessories of Pressure Gauge
Thermometer & Thermometer Switch
Thermocouple & R.T.D.
Thermowell
Transmitter
Indicator etc.
Technical data

General Purpose Head Type

Model No. | SS-5045S
(Sheath)

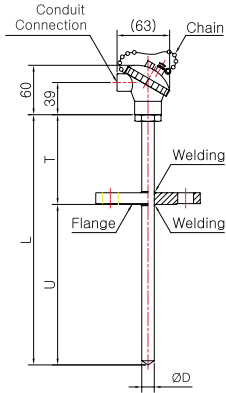

Model No. | SS-5045S-1
(Sheath)

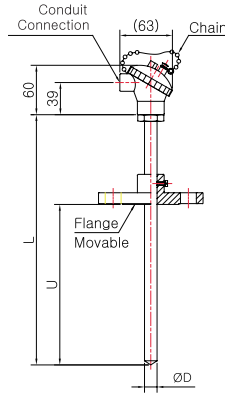

Model No. | SS-5046S-1
(Sheath)

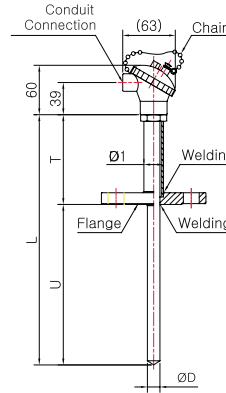

Model No. | SS-5046S-1-1
(Sheath Spring Load)

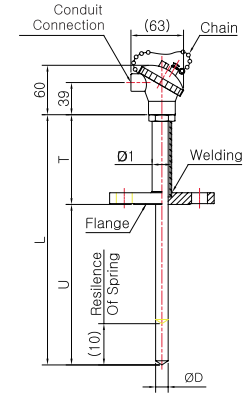

Model No. | SS-5046S-2
(Sheath)

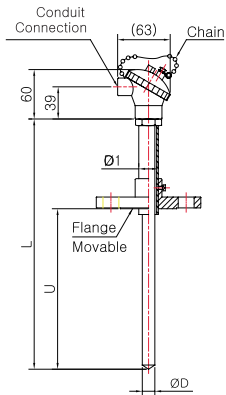

Model No. | SS-5046S-3
(Sheath)

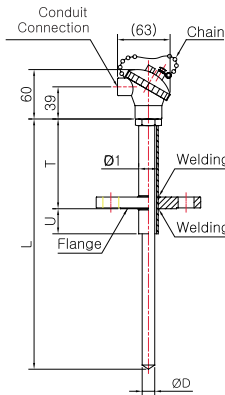

Model No. | SS-5049S
(Sheath)

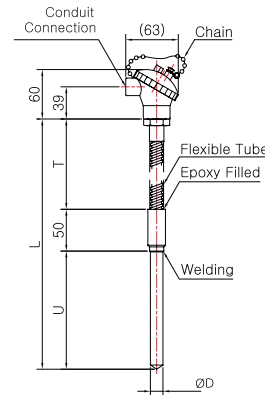

Model No. | SS-5049S-1
(Sheath)

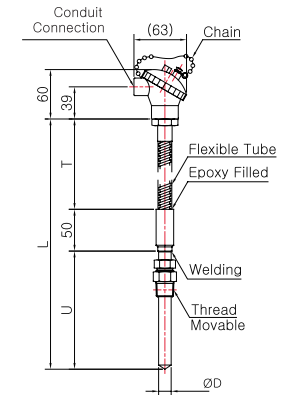

Model No. | SS-5049S-3
(Sheath)

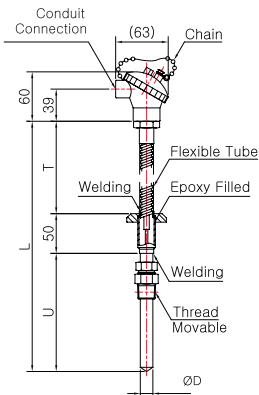

Pressure Gauge

Differential Pressure Gauge & Switch

Accessories of Pressure Gauge

Thermometer & Thermometer Switch

Thermocouple & R.T.D

Thermowell

Transmitter

Indicator etc.

Technical data

Sheath Resistance Temperature Detectors

Model No. SS-5040 Series

Extension Lead Wire Type

Model No. | SS-5048GA
(Basic)

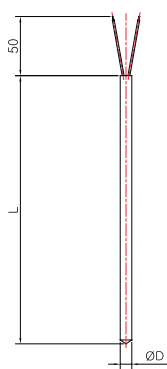

Model No. | SS-5048GB
(Compensating Lead Wire)

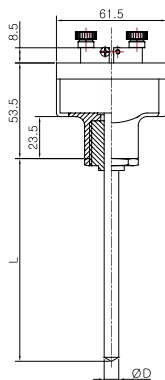

Model No. | SS-5048GC
(Compensating Lead Wire)

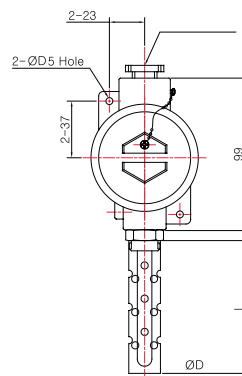

Model No. | SS-5048GD
(Sheath)

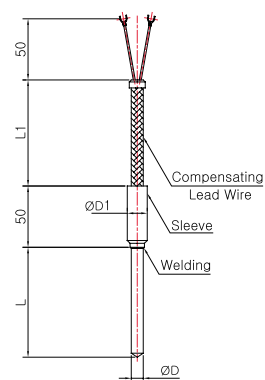

Model No. | SS-5048GD-1
(Compensating Lead Wire)

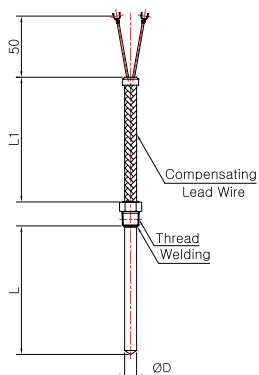

Model No. | SS-5048GD-2
(Sheath)

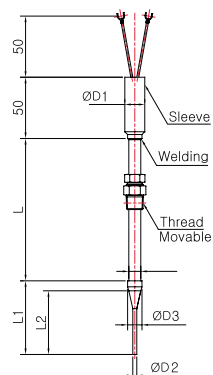

Model No. | SS-5048GDT
(Compensating Lead Wire)

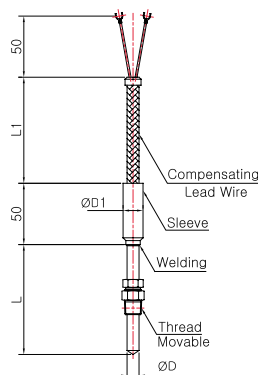

Model No. | SS-5048GE
(Flexible Tube)

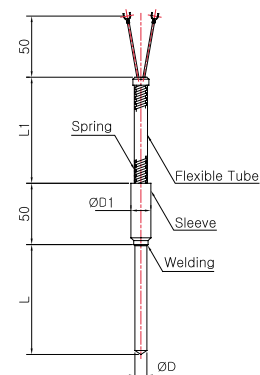

Model No. | SS-5048GET
(Flexible Tube)

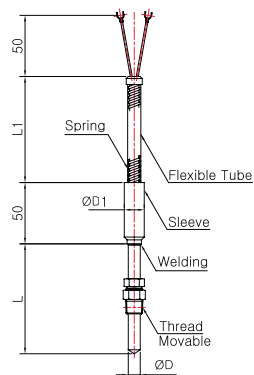

Model No. | SS-5048GF
(Bayonet Mount)

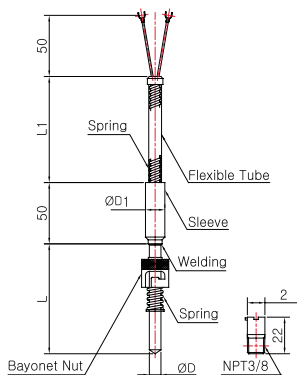

Model No. | SS-5048GG
(Quick Connector)

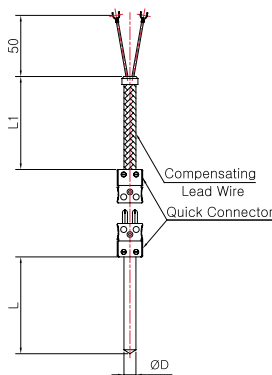

Model No. | SS-5048GH
(Metal Connector)

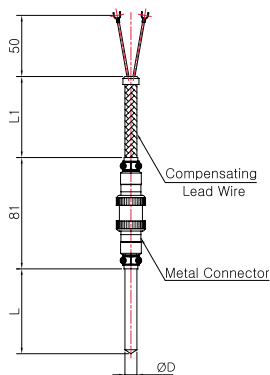

Pressure Gauge
Differential Pressure Gauge & Switch
Accessories of Pressure Gauge
Thermometer & Thermometer Switch
Thermocouple & R.T.D.
Thermowell
Transmitter
Indicator etc.
Technical data

Special Type

Model No. | SS-5049W-A

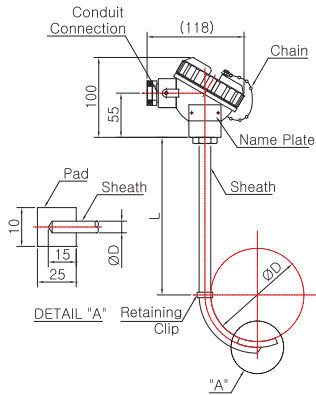

Model No. | SS-5049W-B
(Metal Protection Tube)

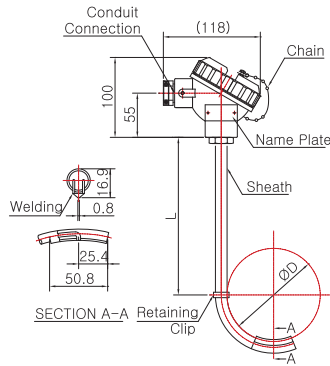

Model No. | SS-5049W-A
(Metal Protection Tube)

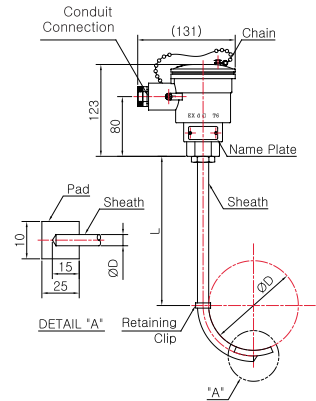

Model No. | SS-5029E-B

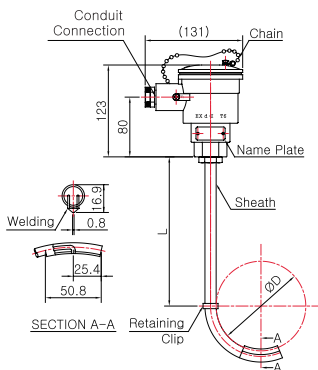

Model No. | SS-5029GDF

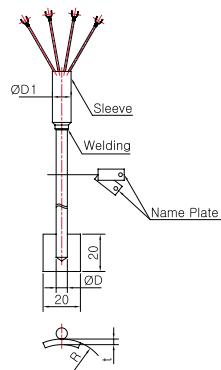

Model No. | MULTI

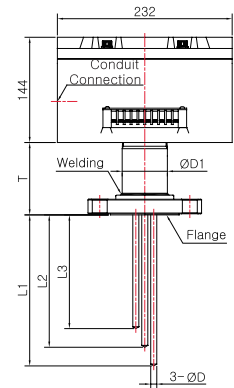

Pressure Gauge

Differential Pressure Gauge & Switch

Accessories of Pressure Gauge

Thermometer & Thermometer Switch

Thermocouple & R.T.D

Thermowell

Transmitter

Indicator etc.

Technical data